



WINNTEC

HD-Series

Truck Service Essentials





Reaching new heights

Winntec (Est. 2002) is a manufacturer, esteemed developer and international supplier of high quality, efficient and reliable automotive workshop “essentials”, available in automotive and industrial markets in Europe, North America, Southern Africa and Pacific Asia. The ranges are “priced right” and backed up by outstanding customer service and support.

Whether you are a tire shop, an automotive workshop, body shop or car dealership, Winntec offers you solutions which are certified to the highest level of useful life (professional use and not occasional use) to ensure maximum value of your investment. All our products are consistently made of the best materials available and constructed and tested in accordance with the latest and most advanced techniques.

TURBO LIFT and **AUTO SHIFT** are just two of the amazing technologies that Winntec introduced during its first decade of existence. Both systems greatly reduce the risk of injury while dealing with heavy loads in and around the shop.

In the years to come we will further intensify our focus on a safe workshop environment. We plan to bring you more innovative products in which ergonomics, ease of use and price remain in perfect balance.

FOR FURTHER INFORMATION AND CONTACT VISIT WINNTEC.NET



HD-Series





Heavy Duty Series

Y410200-Y410400-Y410600-Y410800-Y411000
Y411200-Y411500-Y412000-Y412001-Y413000

Twist top
allows fine
tuning

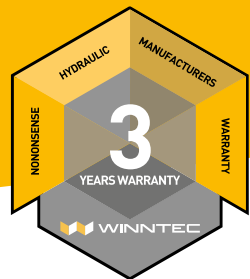

Main features

- Chromed pistons
- Easy maintenance
- Heat-treated saddle

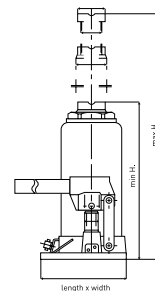

Bottle Jacks

Versatile for use in a large variety of applications: pushing, bending, pressing or straightening. The full range comes with cast iron bases, polished main rams and a solid, chromed pump linkage. These jacks are tested to the latest European standards, have overload protection and can be used in both horizontal and vertical positions. All models (except Y413000 & Y411000) have a twist top for precise height adjustments.

The **telescopic** Y411000 comes with two extensions (45mm+6mm). Winntec guarantees a 3 year warranty due to internally machined oil passages, smooth bearing surfaces and close tolerances.

Model	Base plate (mm)	Min H. (mm)	Lifting H. (mm)	Adjust H. (mm)	Max H. (mm)	T	W
Y410200	96x93	158	90	60	308	2 T	2,3
Y410400	112x104	180	110	60	350	4 T	3,3
Y410600	116x116	197	125	60	382	6 T	4,4
Y410800	120x120	205	125	60	390	8 T	5,4
Y411000	180x118	120	100	-	260	10 T	6,4
Y411200	140x135	214	125	60	399	12 T	7,2
Y411500	140x140	225	140	60	425	16 T	8,3
Y412000	155x140	244	145	60	449	20 T	10,5
Y412001	155x140	190	90	60	340	20 T	9
Y413000	175x160	285	180	-	465	30 T	14,6

In compliance with NEN-EN 1494:2001+A1:2008



Heavy Duty Series

Y420200-Y420301-Y420500-Y421000

The BIG guys

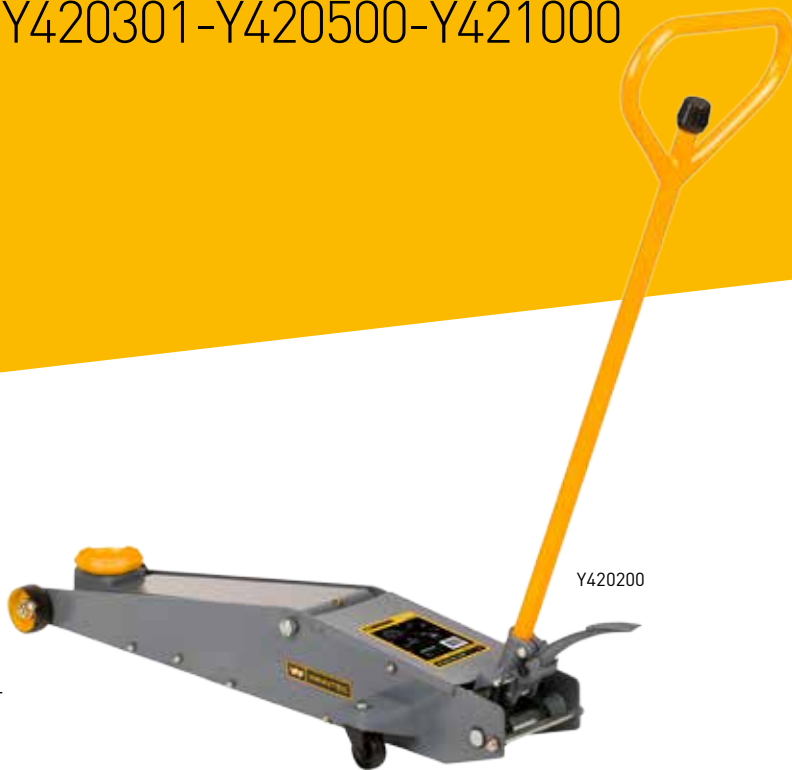

Main features

- Foot pedal
- Ergonomic handle



Long Chassis Jacks

This range is designed especially for extreme heavy-duty lifting. It is perfect for servicing truck fleets, busses, farm- and heavy construction equipment and other vehicles that require a low starting point and a relatively high reach. All models feature a foot-operated pump for quicker lifting efficiency, automatic overload safety valve and swivel casters for easy maneuvering around tight spaces. The ergonomic handle features an integrated load control knob which is in connection with a universal joint release valve.

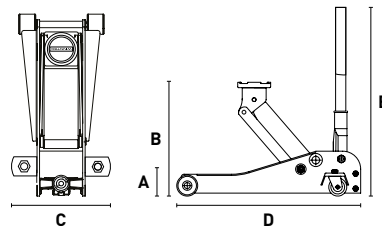

Jack dimensions

A = Min. Height (mm) B = Max. Height (mm) C = Width (mm) D = Length (mm) E = Height (mm)

Model	A	B	C	D	E		
Y420200	138	800	396	1310,5	1285	2 T	58
Y420301	130	600	325	1400	1330	3 T	65
Y420500	150	680	366	1505	1345	5 T	90
Y421000	160	680	485	1635	1355	10 T	145

In compliance with NEN-EN 1494:2001+A1:2008



Heavy Duty Series

Y432021-Y432020-Y432003

Best in class



Y432020

Main features

- Welded base
- Extension screw
- High speed air motor
- Chromed ram



Y432003

Y432021



Air Bottle Jacks

Premium quality 20 Ton air & air/manual bottle jacks. These models feature a aluminum air motor, specially heat treated cylinder walls and chrome pistons ensuring premium performance, durability, life and safety. Filters prevent contaminates from entering the air/hydraulic system.

Y432003 can be stored vertically. **Y432021** offers no manually operated pump.

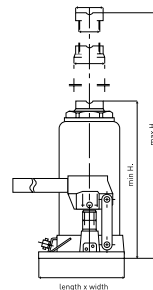

Model	Base plate (mm)	Min H. (mm)	Lifting H. (mm)	Adjust H. (mm)	Max H. (mm)	Weight	Capacity
Y432021	180x115	148	66.6	45	260	20 T	9
Y432020	220x175	245	150	80	475	20 T	16.5
Y432003	300x150	253	150	80	483	20 T	25.7

In compliance with NEN-EN 1494:2001+A1:2008



Heavy Duty Series

Y432024

Air
controlled
descent



Main features

- Pneumatic descend
- Dead-man control
- Extension screw

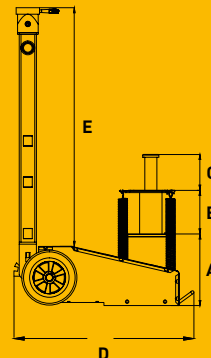

Air Service Jack - Single Stage

This single stage air service jack delivers a massive 24 Ton of power and is guaranteed with a unique 3 year warranty on its interior hydraulic and pneumatic components. It is designed to meet and exceed expectations of a quality jack at a very competitive market value.

The controller allows for the jack to ascend and descend with air. No more relatively unsafe, manual descending of heavy trucks! This Y432024 comes with 3 extensions (20mm-50mm-100mm) and is equipped with a 85mm extension screw. The heavy duty wheels have been designed for daily use. Hard chromed piston.

Specifications

A = 215 mm

B = 141 mm

C = 85 mm

D = 525 mm

E = 1240 mm

F = 265 mm

24 T

40 kg



Heavy Duty Series

Y432032

Low clearance -
Maximum mobility



Main features

- Chromed pistons
- 150mm entry height
- Compact body

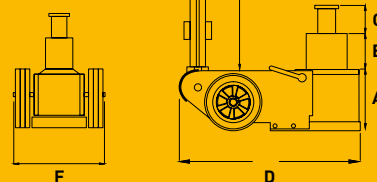

Air Service Jack - Telescopic

Dual stage air service jack with a low entrance height of just 150mm and hard chromed piston. With 32/16 Ton capacity and its compact dimensions, this jack is ideal for both workshop and road assistance duty.

The controller allows the jack to ascend and descend with air. This premium Y432032 is backed with 3 year warranty. Air controlled descent ensures maximum safety while dealing with heavy loads.

This Y432032 comes with 2 extensions (45mm-100mm). As an option we offer a 260mm extension which is a great help when lifting trailers.

Specifications

A = 150 mm

B = 73 mm

C = 66 mm

D = 480 mm

E = 1300 mm

F = 290 mm

 32/16 T

 38 kg



Heavy Duty Series

Y471105

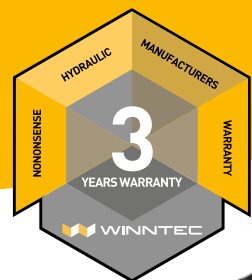

Main features



- Quick detach handle
- Extended rollers - 290mm



Wheel Dolly

This industrial quality wheel dolly increases productivity in the shop by offering a fast & efficient way to remove the tire/wheel assembly. Its ergonomic design helps to reduce workplace back strain injuries. The extended rollers (ideal with wide base tires) can be installed in 3 positions depending on the wheel size. The roller bearings are of Japanese origin. The rubber wheels have an all new and unique steel core providing optimal life time performance.

Specifications

Frame width	700 mm
Handle length	1000 mm
 Weight	220 kg
 Roller weight	15 kg



Heavy Duty Series

Y471106

INNOVATION
AWARD
PARTICIPANT
AUTOMECHANIKA
2 0 1 6



Main features

- Carry handle & belt
- Maximum mobility
- Fast positioning

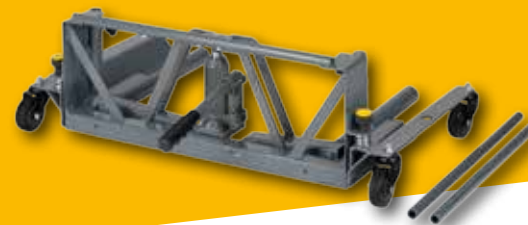



COMING
SOON

SAFERGO Wheel Dolly

This lightweight, portable dolly has a compact hydraulic unit that ensures precise positioning. It also allows the operator to work on a very short distance from the vehicle which is crucial during road assistance service work. Its shock absorbing casters ensure a smooth ride from and to the hub on a rough surface.

Winntec delivers you once again affordable ergonomics without affecting operation speed.

Specifications

Frame width	680 mm
Frame depth	470 mm
Frame height	280 mm
 Weight	150 kg
 Weight	25 kg





WINNTEC

Uplifting Quality & Service!



WINNTEC

10T

Y421000

1



2

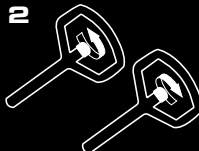

3

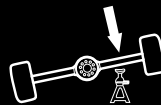

4

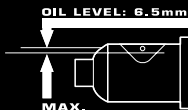

5



HEAVY DUTY SERIES

WINNTEC.NET



We



Jacks

Lifting devices sold since 2002

In compliance with NEN-EN 1494:2001+A1:2008 **CE**